

SaiWin[®] by Sine Audio

Powered Bookshelf Speakers
5-Inch / 4-Inch / 3.5-Inch
2.0 Channel Stereo





DS6801 | DS6801S | DS6701 | DS6701S

User Manual

E-mail: support@sineaudio.com.cn

> Important Notes

- In order to reduce the bottom noise at low volume, please do not minimize the volume of the audio source, it is recommended that the volume of the audio source is greater than 50%, and then turn down the volume by adjusting the speakers. 
- Recommended to use optical cable to connect with your TV, Bluetooth connection may cause audio delay.
- To avoid hearing distorted sound, turn off your TV speakers (except for the headphone socket connection), check the sound is only coming from the bookshelf speakers.
- For digital audio(SPDIF) / optical connection, please change your TV audio output to digital audio / optical, and change the audio format setting to PCM, and make sure the protective caps at the ends of the optical cable are removed before plugging it in.
- The IR code of the remote control is not compatible with universal remote and TV remote, and it is effective within 5 meters. Bass and Treble Not Adjustable. 
- The bookshelf speakers does not support Dolby and DTS, please kindly disable the Dolby and DTS via your TV audio setting or streaming video APP audio setting.
- Lip sync or audio delay issue could be fixed via TVs audio delay settings.
- For the better sound quality, please set the volume of the bookshelf speakers to 80 percent of maximum (Note: the maximum volume drop 2 levels is 80 percent) and set the volume of your source device to a suitable level.
- To get a better sound effect, press the movie, music or news button on the remote control to select a suitable sound mode.
- For audio cable connection, you can boost / restore the volume by double clicking the boost button on the remote control.
- The audio output of the bookshelf speakers is affected by the settings of the connected source.If necessary, adjust the settings of the source to improve the audio output.
- Not all remote control function buttons can be found on the bookshelf speakers. Please keep the remote control properly.
- Disconnect the power adapter from the electrical outlet to power off your speakers completely.



→ Do not make unauthorized alterations to the system, doing so may compromise safety, regulatory compliance, and may void the warranty.

→ This system contains magnetic material, contact your physician if you have questions on whether this might affect the operation of your implantable medical device.

> Warranty Information

The warranty period for this product is 12 months from the date of its original purchase. If manufacturing defects occur, please contact your dealer at the first time, we will instruct

you on how to return the defective unit back to us for repair or replacement.

The following are excluded from the Sine Audio warranty coverage:

- Product over warranty.
- Damage resulted from misuse and abusive action.
- Damage resulted from chemical, fire, radioactive substance, and poison, liquid.
- Damage resulted from natural disaster.
- Remove all packaging and check for the presence of all parts and for transport damage. In case of damage or incomplete delivery, please contact your dealer.
- Please keep the packaging. The system can be stored in it, if not used for a longer period of time.
- Make sure the power adapter is disconnected from the electrical outlet before making any mounting and connection.
- During operation, if the cables require to be reconnected, the power adapter must be disconnected first, otherwise damage to the system may result.

> FCC Information

This device complies with part 15 of the FCC Rules. Operation is subject to the following two conditions:(1) this device may not cause harmful interference, and (2) this device must accept any interference received, including interference that may cause undesired operation.

Changers or modifications not expressly approved by the party responsible for compliance could void the user's authority to operate this equipment.

Note: This equipment has been tested and found to comply with the limits for a Class B digital device, pursuant to Part 15 of the FCC Rules. These limits are designed to provide reasonable protection against harmful interference in a residential installation. This equipment generates, uses, and can radiate radio frequency energy and, if not installed and used in accordance with the instructions, may cause harmful interference to radio or television reception, which can be determined by turning the equipment off and on, the user is encouraged to try to correct the interference by one of more of the following measure:

- Reorient or relocate the receiving antenna.
- Increase the separation between the equipment and receiver.
- Connect the equipment into an outlet on a circuit different from that to which the receiver is connected.
- Consult the dealer or an experienced radio/TV technician for help.

This device has been evaluated to meet general RF exposure requirement. The device can be used in portable exposure condition without restriction.

> Package Contents

1 X Bookshelf speakers - pair

Accessories:	1 X Power adapter	1 X Speaker wire cable
	1 X Optical cable	1 X 3.5mm RCA audio cable
	1 X User manual	1 X Remote control

Note: Accessories are subject to change without notice.

> Features

- 5-Inch / 4-Inch / 3.5-Inch woofer
- 2.0 channel stereo two way speaker system
- Analog audio interface (AUX input)
- Digital audio interface (optical input and coaxial input)
- Stream music from smart phone or tablet
- Full function infrared remote control

>> Important notes

- Remove the protective caps at both ends of the optical cable before plugging it in.
- For coaxial connection, please use standard coaxial cable with shielding.
- If you feel the bass is too heavy or the vocals are not enough, press the music or news button on the remote control.
- Flashing blue light indicates that the speaker is in Bluetooth pairing mode.
- If the speaker is already connected to a Bluetooth device, the current connection must be disconnected before connecting to a new Bluetooth device.
- Long pressing the BT button on remote or M button on speaker to disconnect quickly.
- SUB output socket is only for the powered subwoofer connection. If the bass is poor, please try to switch the polarity of the subwoofer.



> Specifications

Power adapter	Input : 100-240VAC 50/60Hz	
	Output : 20V 2.0-2.5A 18V 2.0A 18V 1.66A	
	DS6801/6801S/6701	DS6701S
Output power :	40W X 2	30W X 2
Signal to noise ratio :	85dB (A-weighting)	83dB (A-weighting)
Frequency response :	45Hz – 20KHz	50Hz – 20KHz
Total harmonic distortion :	0.5% (20KHz LPF)	0.5% (20KHz LPF)
Standby power :	Less than 0.5W	
Digital audio format:	PCM / 32KHz - 96KHz / 16bit - 24bit	

Note: Specifications are subject to change without notice.

>> Subwoofer out

Frequency Response
25Hz-180Hz(-3dB)

Note :

→ SUB output socket is only for the powered subwoofer connection.

If the bass is poor, please try to switch the polarity of the subwoofer.

→→ DS6701S without subwoofer output socket.

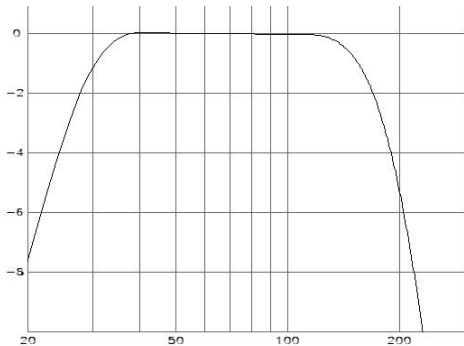

< Subwoofer out Frequency Response Curve >

→ In order to reduce the bottom noise at low volume, please do not minimize the volume of the audio source, it is recommended that the volume of the audio source is greater than 50%, and then turn down the volume by adjusting the speakers.

> DS6701S Rear Panel

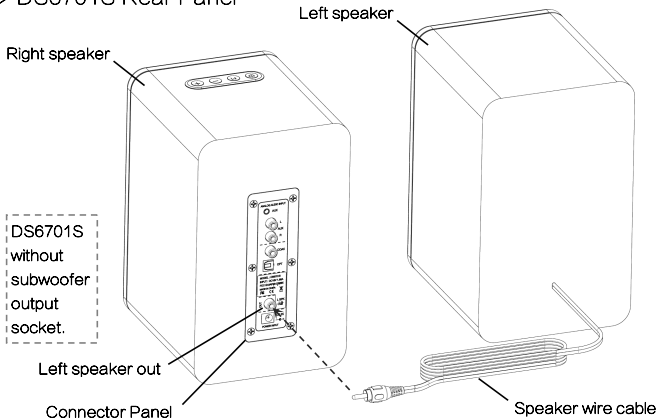

→ Connect the left and right speakers via the speaker wire cable.

>> Button Panel

>>> Press and hold power button 1S to turn on/off.

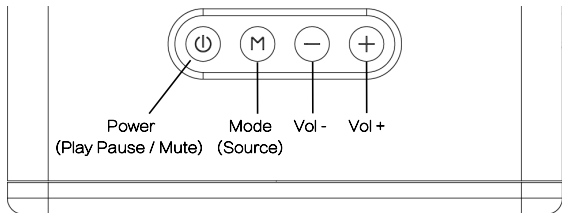

→ Power on / off : Press and hold 1S

→ Play Pause / Mute : Short click

- Press the Mode (Source) button to toggle between the AUX, BT, COAX, OPT sources, The AUX, BT, COAX, OPT source indicator will light up red accordingly.

>> DS6801 / DS6801S / DS6701 Rear Panel

→ Please connect the speaker wire cable before plugging the DC power plug into the bookshelf speaker.

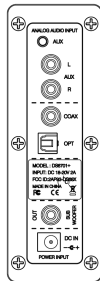

→ When connecting the left and right speakers via the speaker wire cable, please note that the golden wire is connected to the positive terminal of the terminal clips and the silver wire is connected to the negative terminal of the terminal clips.



>> Source indicators

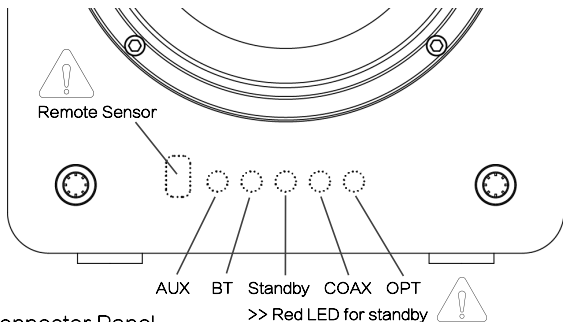

>> Connector Panel

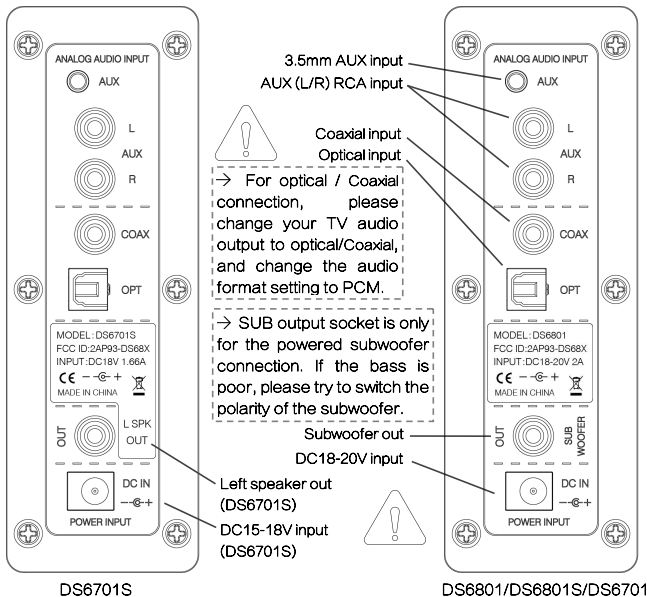

>> Remote control

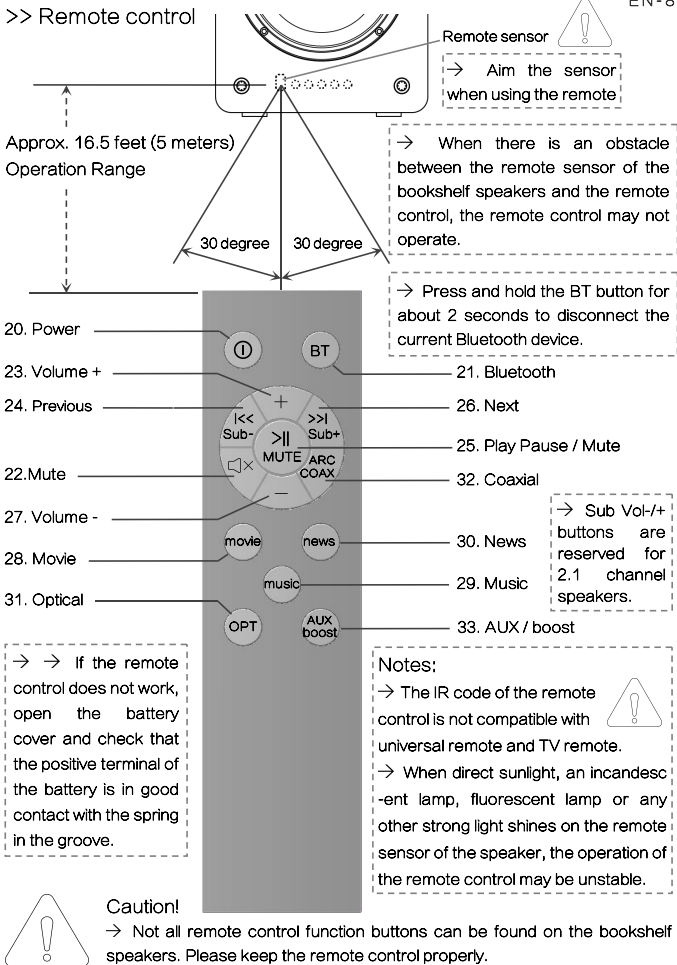

> Setting Up the System

>> Unpacking

- Remove all packaging, check for the presence of all parts and for transport damage. In case of damage or incomplete delivery, please contact your dealer.
- Please keep the packaging. The system can be stored in it, if not used for a longer period of time.



>> Digital audio (SPDIF) connection

- Use the supplied optical cable or Coaxial cable (not supplied) to connect the bookshelf speakers to a TV, DVD, Blu-Ray Player or other suitable devices.
- Connect one end to the optical or coaxial (SPDIF) out socket of the TV, DVD, Blu-Ray Player or other suitable devices.
- Connect the other end to the optical or coaxial input socket of the bookshelf speakers.

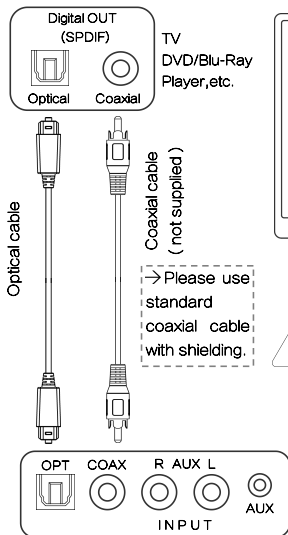

- The bookshelf speakers does not support Dolby and DTS, please kindly disable the Dolby and DTS via your TV audio setting or streaming video APP audio setting.
- Lip sync or audio delay issue could be fixed via TVs audio delay settings.

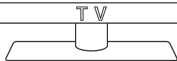

- Please use standard coaxial cable with shielding.



- Recommended to use optical cable to connect with your TV, Bluetooth connection may cause audio delay.
- Remove the protective caps at both ends of the optical cable before plugging it in.

Note: For digital audio(SPDIF) / optical connection, please change your TV audio output to digital audio / optical, and change the audio format setting to PCM, and make sure the protective caps at the ends of the optical cable are removed before plugging it in.

> Setting Up the System

- Make sure the power adapter is disconnected from the electrical outlet before making any mounting and connection.
- During operation, if the cables require to be reconnected, the power adapter must be disconnected first, otherwise damage to the system may result.



>> Audio cable connection

- Connect the bookshelf speakers to a TV, DVD, Blu-ray player or other suitable device using an RCA audio cable (not supplied).
- Connect one end to the audio out or line out sockets of the TV, DVD, Blu-Ray Player or other suitable devices.
- Connect the other end to the 3.5mm AUX input socket of the bookshelf speakers.

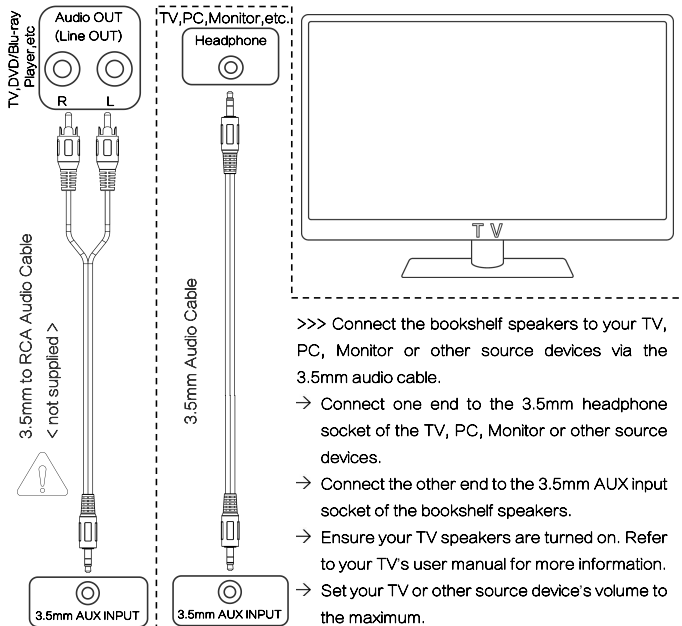

Note: For audio cable connection, you can boost / restore the volume by double clicking the boost button on the remote control.

> Using the System

>> Using the remote control

>>> Inserting / replacing batteries

1. Slide to open the battery compartment cover.
2. Insert 2 X 1.5V AAA batteries (not supplied) into the battery compartment. Match the polarity markings in the battery compartment.
3. Close the battery compartment cover.

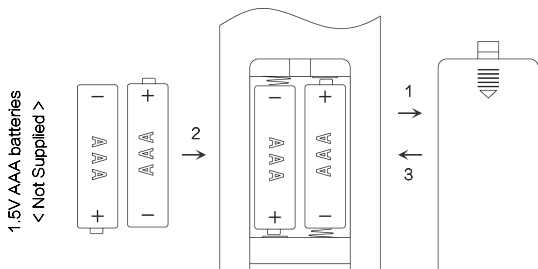

→ If the remote control does not work, open the battery cover and check that the positive terminal of the battery is in good contact with the spring in the groove.



Caution!

- The bookshelf speakers can only work with the remote control package included, not compatible with universal remote control.
- Always insert the batteries according to the correct polarity markings.
- Use only high quality batteries, low quality batteries might leak and cause damage.
- Remove the batteries from the remote control if you are not using it for an extended period. The remote control could become damaged in case of battery leakage.

>>> Tips for usage

- If the remote control does not work properly, replace the batteries.
- Make sure there are no obstacles between the remote control and bookshelf speaker.
- The remote control may be less effective if:
 1. There are obstacles between the remote control and the infrared receiver.
 2. Other remote controls are operated at the same time.
 3. The battery power is low.

> Using the System

>> Get power and started

Make sure all the source connections are made properly before you connect the power adapter. Plug the power adapter to the DC IN socket, then to a suitable electrical outlet.

The power indicator lights up red. Indicating the bookshelf speakers is in standby mode.

- Turning off your TV speakers; To avoid hearing distorted sound, turn off your TV speakers (except for the headphone socket connection , Refer to " Audio cable connection " for more information).
- Power on your bookshelf speakers; Press the Power button on the bookshelf speakers or remote control. The power indicator lights up.
- Check if sound is coming from the bookshelf speakers.

>> Selecting a sound mode (Movie / Music / News)

- To get a better sound effect, press the movie, music or news button on the remote control to select a suitable sound mode.
- There is no sound mode button on the bookshelf speakers, Please keep the remote control properly.
- The recommended sound mode selections as below:

Program source	Sound mode	Program source	Sound mode
Strong bass film	Music or news	Strong bass music	Music or news
General film	Movie or music	Pop music	Movie or Music
Documentary	Music or news	Light music	Music or news
Variety show	Music or news	News / Dialog	Music or news

Notes:

- For the better sound quality, please set the volume of the bookshelf speakers to 80 percent of maximum (Note: the maximum volume drop 2 levels is 80 percent) and set the volume of your source device to a suitable level.
- There is no sound mode indicator on the bookshelf speakers. 
- The sound mode selection and the volume settings are saved in the memory even after the bookshelf speakers is powered off, and the volume setting from 80 percent to maximum will be saved to 80 percent.
- Set the volume of your source device to a low level before switching on the bookshelf speakers. Then increase the volume of your source device to a comfortable level.
- Disconnect the power adapter from the electrical outlet to power off your bookshelf speakers completely.

> Using the System

>> Basic functions

>>> Selecting a source

- You can have several source devices connected permanently to the speakers.
- Available sources are: OPT / COAX / BT / AUX

Source	Function
OPT	Optical , connection with an optical fiber cable.
COAX	Coaxial, connection with a coaxial cable(not supplied).
BT	Bluetooth, Connection to a Bluetooth Device.
AUX	Auxiliary, Connection with a 3.5mm to RCA audio cable (not supplied).
	Auxiliary, Connection with a 3.5mm to 3.5mm audio cable.

- Press the M (Mode) button repeatedly on the bookshelf speakers or press the OPT, COAX, BT, AUX button on the remote control to toggle between the sources, The OPT, COAX, BT, AUX source indicator will light up accordingly.
- You can boost / restore the volume by double clicking the boost button on the remote control when you use AUX source (audio cable connection).

>>> Play back functions

- Normally playback functions can be managed through the controls of the connected source device.
- Alternatively, use the remote control and the buttons of the bookshelf speakers.

Key	Press Key	Function
M	1 X	Source selection
	Long press 2 second	Disconnecting the Bluetooth device
Mute 	1 X	Pause / Mute sound (Flash the indicator light).
	2 X	Play / Restore sound.
- / +	1 X	Volume down / Volume up
> / mute	1 X	Pause / Mute sound (Flash the indicator light).
	2 X	Play / Restore sound.

Notes:

- The volume boost / restore and mode (source) selections are saved in the memory even after the bookshelf speakers is powered off.
- The audio output of the bookshelf speakers is affected by the settings of the connected source. If necessary, adjust the settings of the source to improve the audio output.

> Using the System

>> Bluetooth function

External Bluetooth devices can be connected to the TV bookshelf speakers system via Bluetooth connection.

1. Press the BT button on the remote control to enter the Bluetooth mode. The Bluetooth indicator lights up blue.
2. Activate the Bluetooth function of the external device and search for Bluetooth devices.
3. Select the bookshelf speakers (Sine Audio) from the Bluetooth device list.
4. Follow the instructions shown on your device's screen.
5. When the Bluetooth connection is established, files from your connected Bluetooth device will be played through the bookshelf speakers.

>> Disconnecting the Bluetooth device:

- Press M (Mode) button on the bookshelf speakers to enter AUX or OPT (optical) mode.
- Press the OPT or AUX button on the remote control to enter AUX or OPT (optical) mode.
- Disconnect using your Bluetooth device. The bookshelf speakers starts searching for another Bluetooth device.
- Long press the BT button on the remote control or M (Mode) button on the bookshelf speakers about 2 seconds to disconnect the current Bluetooth device. Long press about 2 seconds again to reconnect the current Bluetooth device.



→ Recommended to use optical cable or audio cable to connect with your TV, Bluetooth connection may cause audio delay.

Notes:

- If you cannot pair your Bluetooth device, you may need to remove the speakers from the pairing list, and try pairing again (see " Troubleshooting " for more information).
- Bluetooth works best within a range of up to 33 feet (10 meters).
- The music streaming may be interrupted by obstacles between the Bluetooth device and bookshelf speakers, such as walls, metallic casing that covers the device, or other devices nearby that operate in the same frequency.
- If the connected device goes out of Bluetooth range, the system will reconnect automatically when the device comes back within range.
- The current Bluetooth device connection is saved in the memory even after the bookshelf speakers is powered off.

> Troubleshooting

Problem	Solution
No power	<ul style="list-style-type: none"> → Check the power adapter is properly connected to an electrical outlet. → Check the DC plug is properly connected to the DC IN socket. → Unplug the power adapter for at least one minute and reconnect.
No Sound	<ul style="list-style-type: none"> → Press the Power button on the speakers or remote control to turn on the bookshelf speakers. The mode(source) indicator lights up. → Press MUTE button on the remote control to restore sound. → Ensure that the source device has correct volume settings and is playing a track. → Ensure the correct source device is selected. → Plug the audio cable into a connector on your TV labeled Line OUT or Audio OUT, not Line IN or Audio IN. <p>Digital audio (SPDIF) connection:</p> <ul style="list-style-type: none"> → Plug the optical cable into a socket on your TV labeled Optical OUT or Digital OUT, not Optical IN or Digital IN. → Plug the coaxial cable into a connector on your TV labeled Coaxial OUT SPDIF OUT or Digital OUT, not Coaxial IN, SPDIF IN or Digital IN. → Activate PCM (Pulse Code Modulation) in the audio settings menu of your source device(see your source device's user manual). <p>Connect to the headphone socket of TV:</p> <ul style="list-style-type: none"> → Increase your TV's volume to maximum. → Turn on your TV speakers, Refer to your TV's user manual for more information.
Poor audio quality	<ul style="list-style-type: none"> → Press the movie, music or news button on the remote control to select a suitable sound mode. → Set the volume of the bookshelf speakers to 80 percent of maximum (Note: the maximum volume drop 2 levels is 80 percent) . → Secure cable connections on the bookshelf speakers and TV (or other connected sources). → Try with different source devices. If the problem still exists, check the cable connections. → Ensure that the cables connected to the source devices are correctly plugged in and the plugs are fully inserted.

> Troubleshooting

Problem	Solution
Poor audio quality	<p>→ Reduce the volume of your source device.</p> <p>Audio cable connection:</p> <p>→ Double clicking the boost button on the remote control to restore the volume.</p> <p>Bluetooth connection:</p> <p>→ Bring the Bluetooth device closer to the bookshelf speakers and make sure that no obstacles are disturbing the connection.</p>
Remote control does not work	<p>→ Ensure that the batteries are correctly inserted; if necessary, replace the batteries.</p> <p>→ Bring the remote control closer to the bookshelf speakers and make sure there are no obstacles in between. Ensure the remote control is within 16.5 feet (5 meters) of the system.</p> <p>→ Aim the remote control directly at the infrared receiver of the system.</p>
System doesn't react	<p>→ It is malfunction probably due to electrostatic discharge.</p> <p>→ Unplug the power adapter for at least one minute and reconnect.</p>
Bluetooth device cannot be connect to the bookshelf speakers	<p>→ Bring the Bluetooth device closer to the bookshelf speakers.</p> <p>→ Switch off your device and/or bookshelf speakers, then back on, repeat the pairing process.</p> <p>→ Make sure the speakers is not connected another Bluetooth device.</p> <p>→ Make sure that you have selected the bookshelf speakers from the Bluetooth device list on your device.</p> <p>→ Ensure you are using the correct device.</p> <p>If the device is still not connected, try the following:</p> <p>→ Remove the bookshelf speakers (Sine Audio) from the list of "paired devices" on your phone/tablet.</p> <p>→ Turn the bookshelf speakers off and then on again.</p> <p>→ Pair it again with your phone/tablet. It should now successfully establish the pairing.</p> <p>Note: If none of the above solutions works, the Bluetooth device may be malfunctioning. Try another Bluetooth device. If not even the new device can be connected, the bookshelf speakers may be malfunctioning. In this case, please consult your dealer for repair.</p>