

**SaiPin**<sup>®</sup> by Sine Audio

TV Sound Bar System  
2.0 / 2.1 Channel Stereo

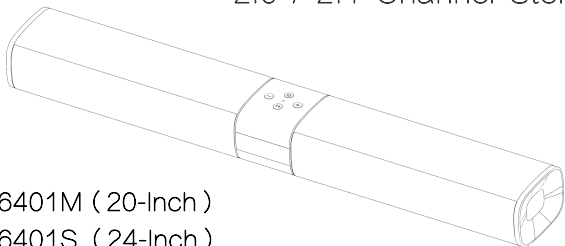

DS6401M ( 20-Inch )

DS6401S ( 24-Inch )

DS6401D / DS6401Pro( 31-Inch )

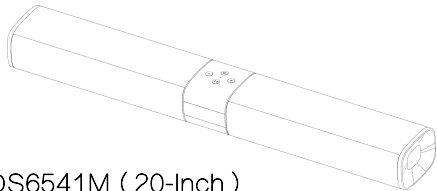

DS6541M ( 20-Inch )

DS6541S ( 24-Inch )

DS6541D / DS6541Pro ( 31-Inch )

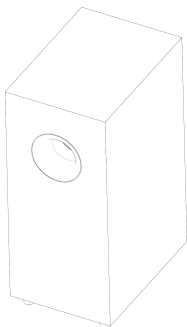

User Manual

E-mail: [support@sineaudio.com.cn](mailto:support@sineaudio.com.cn)

## > Important Notes

- To avoid hearing distorted sound, turn off your TV speakers (except for the headphone socket connection), check the sound is only coming from the sound bar.
- For HDMI ARC / optical (SPDIF) connection, please change your TV audio output to HDMI ARC / optical, and change the audio format setting to PCM, and make sure the protective caps at the ends of the optical cable are removed before plugging it in.
- The IR code of the remote control is not compatible with universal remote and TV remote, and it is effective within 5 meters. Bass and Treble Not Adjustable.
- The sound bar does not support Dolby and DTS, please kindly disable the Dolby and DTS via your TV audio setting or streaming video APP audio setting.
- Lip sync or audio delay issue could be fixed via TVs audio delay settings.
- For the better sound quality, please set the volume of the sound bar to 80 percent of maximum ( Note: the maximum volume drop 2 levels is 80 percent ) and set the volume of your source device to a suitable level.
- To get a better sound effect, press the movie, music or news button on the remote control to select a suitable sound mode.
- The recommended sound mode selections as below:



Program source	Sound mode	Program source	Sound mode
Strong bass film	Music or news	Strong bass music	Music or news
General film	Movie or music	Pop music	Movie or Music
Documentary	Music or news	Light music	Music or news
Variety show	Music or news	News / Dialog	Music or news

- For audio cable connection, you can boost / restore the volume by double clicking the boost button on the remote control.
- The audio output of the sound bar is affected by the settings of the connected source. If necessary, adjust the settings of the source to improve the audio output.
- Not all remote control function buttons can be found on the sound bar. Please keep the remote control properly.
- Disconnect the power adapter from the electrical outlet to power off your sound bar completely.



- The lightning flash with arrowhead symbol within an equilateral triangle alerts the user to the presence of uninsulated, dangerous voltage within the system enclosure that may be of sufficient magnitude to constitute a risk of electric shock.



- The exclamation point within an equilateral triangle, as marked on the system, is intended to alert the user to the presence of important operating and maintenance instructions in this user manual.



- Do not make unauthorized alterations to the system, doing so may compromise safety, regulatory compliance, and may void the warranty.
- This system contains magnetic material, contact your physician if you have questions on whether this might affect the operation of your implantable medical device.

## > Warranty Information

The warranty period for this product is 12 months from the date of its original purchase. If manufacturing defects occur, please contact your dealer at the first time, we will instruct you on how to return the defective unit back to us for repair or replacement.

The following are excluded from the Sine Audio warranty coverage:

- Product over warranty.
- Damage resulted from misuse and abusive action.
- Damage resulted from chemical, fire, radioactive substance, and poison, liquid.
- Damage resulted from natural disaster.

## > FCC Information

This device complies with part 15 of the FCC Rules. Operation is subject to the following two conditions:(1) this device may not cause harmful interference, and (2) this device must accept any interference received, including interference that may cause undesired operation.

Changes or modifications not expressly approved by the party responsible for compliance could void the user's authority to operate this equipment.

Note: This equipment has been tested and found to comply with the limits for a Class B digital device, pursuant to Part 15 of the FCC Rules. These limits are designed to provide reasonable protection against harmful interference in a residential installation. This equipment generates, uses, and can radiate radio frequency energy and, if not installed and used in accordance with the instructions, may cause harmful interference to radio or television reception, which can be determined by turning the equipment off and on, the user is encouraged to try to correct the interference by one of more of the following measure;

- Reorient or relocate the receiving antenna.
- Increase the separation between the equipment and receiver.
- Connect the equipment into an outlet on a circuit different from that to which the receiver is connected.
- Consult the dealer or an experienced radio/TV technician for help.

This device has been evaluated to meet general RF exposure requirement. The device can be used in portable exposure condition without restriction.

## > Package Contents

1 X Sound bar

### Accessories:

1 X Power adapter

1 X Optical cable

1 X User manual

1 X 3.5mm audio cable

1 X Remote control

1 X Passive subwoofer ( DS6541 only )



2 X Wall anchors ( For wall mounting )

2 X Screws ( For wall mounting )

## > Features

- 2.0 / 2.1 channel stereo TV sound bar system
- 20-Inch / 24-Inch / 31-Inch sound bar for TVs
- Analog audio interface ( 3.5mm AUX input )
- Digital audio interface ( HDMI ARC input and optical input )
- Stream music from smart phone or tablet
- Full function infrared remote control

## > Important notes

- Remove the protective caps at both ends of the optical cable before plugging it in.
- If you feel the bass is too heavy or the vocals are not enough, press the music or news button on the remote control. 
- In order to reduce the bottom noise at low volume, please do not minimize the volume of the audio source, it is recommended that the volume of the audio source is greater than 50%, and then turn down the volume by adjusting the speakers.
- If the speaker is already connected to a Bluetooth device, the current connection must be disconnected before connecting to a new Bluetooth device. 

## > Specifications

Power adapter	Input :	100-240VAC 50/60Hz
	Output :	14.8V1.6A   15V1.2A   17.5V1.1A   17.8V1.33A   18V1.66A

### >> Sound bar

Output power :	Frequency response :
25W X 2 (DS6401S/6401M)	70Hz – 20KHz (DS6401S/6401M)
30W X 2 (DS6401D/6401Pro)	65Hz – 20KHz (DS6401D/6401Pro)
25W X 2 + 40W (DS6541S/6541M)	50Hz – 20KHz (DS6541S/6541M)
30W X 2 + 40W (DS6541D/6541Pro)	45Hz – 20KHz (DS6541D/6541Pro)
Signal to noise ratio: 80dB (A-weighting)	Total harmonic distortion : 0.5% (20KHz LPF)
Standby power : Less then 0.5W	Digital audio format: PCM/16-24bit/16-48KHz

Note: Accessories and specifications are subject to change without notice.

## > System Overview

### >> Front View

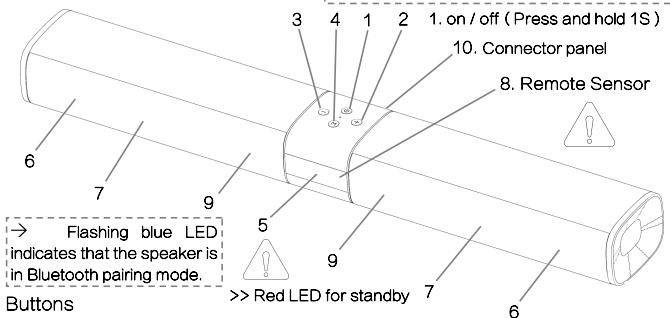

#### Buttons

1. on / off (Press and hold 1S)    Play / Pause (short click)  
 2. Volume up                              3. Volume down                              4. Mode (Source)

#### Source indicators    >> Red LED for standby

5. Indicate LED    >> OPT (Purple)    BT (Blue)    AUX (Green)    HDMI ARC (White)  
 6. Speaker driver                              7. Speaker driver (Tweeter, DS6401D / DS6401Pro)  
 8. Remote sensor                              9. Bass reflex tube                              10. Connector panel

### >> Connector panel

→ HDMI (ARC) for TV connection only

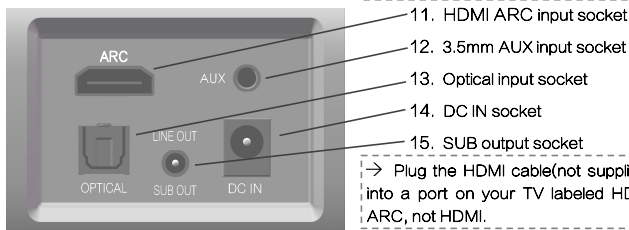

→ Recommended to use optical cable to connect with your TV, Bluetooth connection may cause audio delay.    → Remove the protective caps at both ends of the optical cable before plugging it in.

#### Notes:

- For the DS6541 (2.1 channel), SUB output socket connects to the passive subwoofer.
- For the DS6401 (2.0 channel), SUB output socket is only for the powered subwoofer connection. If the bass is poor, please try to switch the polarity of the subwoofer.

## &gt;&gt; Remote control

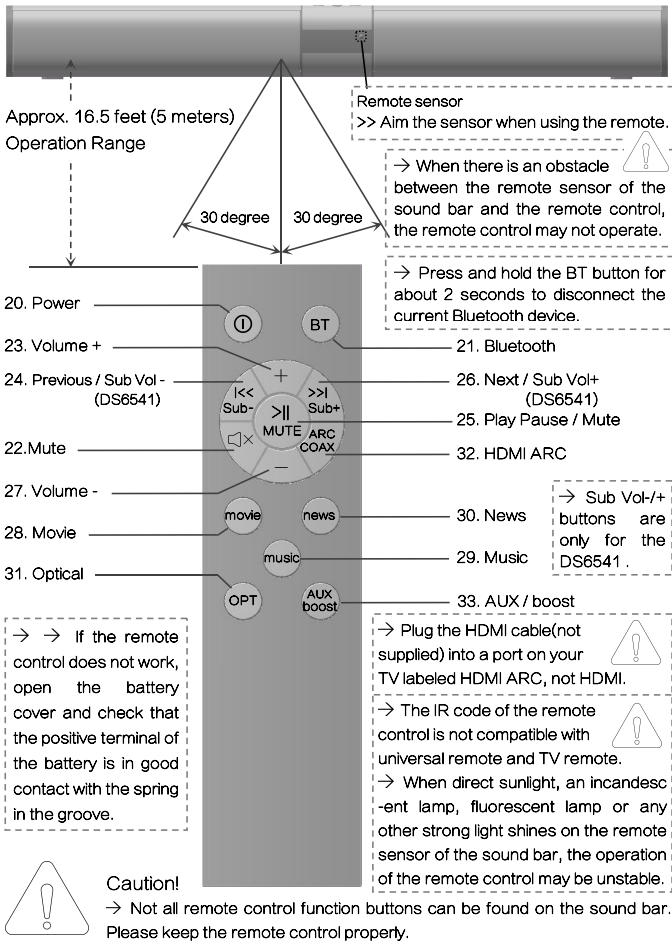

## > Setting Up the System

---

Make sure that the cables connected to the source device and the speakers are properly plugged in and the plugs are fully inserted.

---

### >> Unpacking

- Remove all packaging.
- Check for the presence of all parts and for transport damage. In case of damage or incomplete delivery, please contact your dealer.
- Please keep the packaging. The system can be stored in it, if not used for a longer period of time.

### >> Preparation

The Sound bar system serves as an audio output device and features wireless and wired connections. You can place the sound bar on a horizontal surface or mount it on a wall.

When mounting it on a wall, pay attention to the following:

- The supplied wall mount brackets, wall anchors and screws can be used to fix the sound bar to a wall. The wall mount brackets are designed for vertical walls constructed of solid concrete, bricks or wooden.
- When installing on a cinder block wall, first verify that the blocks have a minimum of 1.2 inch (3cm) of actual concrete wall thickness to be used for the wall anchors.
- If you are uncertain about the construction of your wall, please consult a qualified contractor or installer for assistance.
- Ensure that the wall anchors and screws you use are stronger enough to support the weight of the sound bar and long enough to sufficiently grip the wall.
- It is strongly recommended to use the supplied wall anchors and screws.
- Additional tools (not included) are required for the installation.
- Do not over tighten screws.
- Use an electronic stud finder to check the wall type before drilling and mounting.
- During mounting, keep away children and pets.
- Make sure the sound bar is mounted in reach of a wall outlet.

#### Caution!



When placing the sound bar on an entertainment center, bookshelf, or any type of enclosed space, be sure to allow at least 2 inches (5cm) of space around the sound bar for ventilation. If the sound bar is enclosed in a tight space, without ventilation, heat generated from the sound bar could produce a potential heat hazard.

## > Setting Up the System



### Caution!

- Make sure the power adapter is disconnected from the electrical outlet before making any mounting and connection.
- During operation, if the cables require to be reconnected, the power adapter must be disconnected first, otherwise damage to the system may result.

## >> Wall mounting

1. The distance between two brackets of the sound bar.

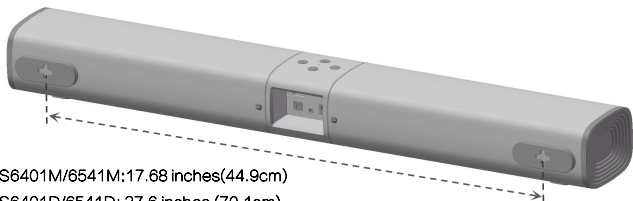

DS6401M/6541M: 17.68 inches (44.9cm)

DS6401D/6541D: 27.6 inches (70.1cm)

DS6401Pro/6541Pro: 27.6 inches (70.1cm)

DS6401S/6541S: 20.6 inches (52.3cm)

2. Mark the position and drill 2 holes in the wall.

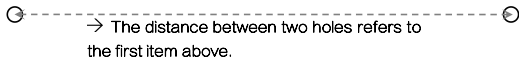

3. Insert 2 wall anchors into the holes, use a hammer if necessary.

4. Secure the supplied screws into the anchors and leave approx. 0.1 inch (2.54mm) length to hook the sound bar.

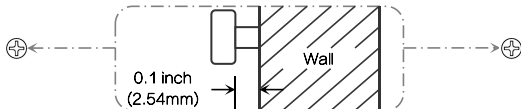

5. Hang the sound bar onto the screws. Make sure they are firm and stable.





## > Setting Up the System

### >> Digital audio (SPDIF) / Sub out, Line out connection

- Use the supplied optical cable /HDMI Cable (not supplied) to connect the sound bar to a TV, DVD, Blu-Ray Player or other suitable devices.
- Connect one end to the optical out socket /HDMI(ARC) socket of the TV, DVD, Blu-Ray Player or other suitable devices.
- Connect the other end to the optical /HDMI(ARC) input socket of the sound bar.

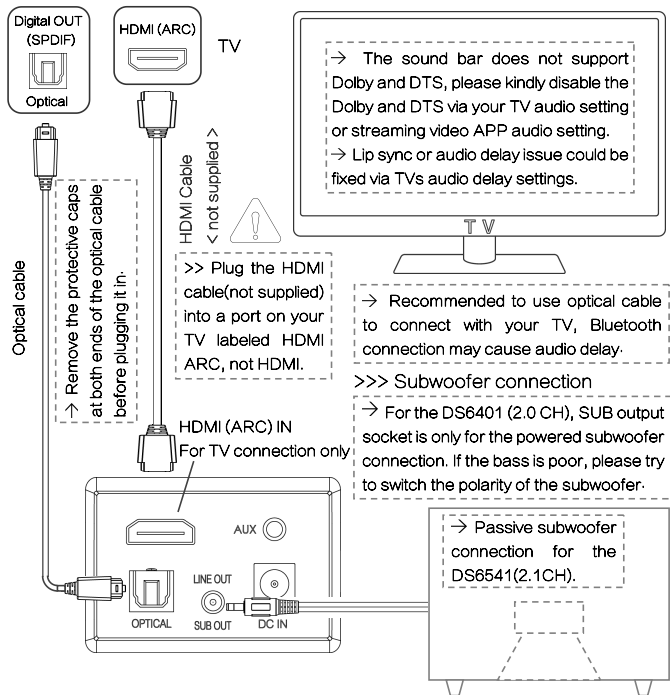

Note: For HDMI ARC / optical (SPDIF) connection, please change your TV audio output to HDMI ARC / optical, and change the audio format setting to PCM, and make sure the protective caps at the ends of the optical cable are removed before plugging it in.

## > Setting Up the System

### >> Audio cable connection

- Connect the soundbar to a TV, DVD, Blu-ray player or other suitable device using an RCA audio cable (not supplied).
- Connect one end to the audio out or line out sockets of the TV, DVD, Blu-Ray Player or other suitable devices.
- Connect the other end to the 3.5mm AUX input socket of the sound bar.

TV, DVD/Blu-ray Player, etc.

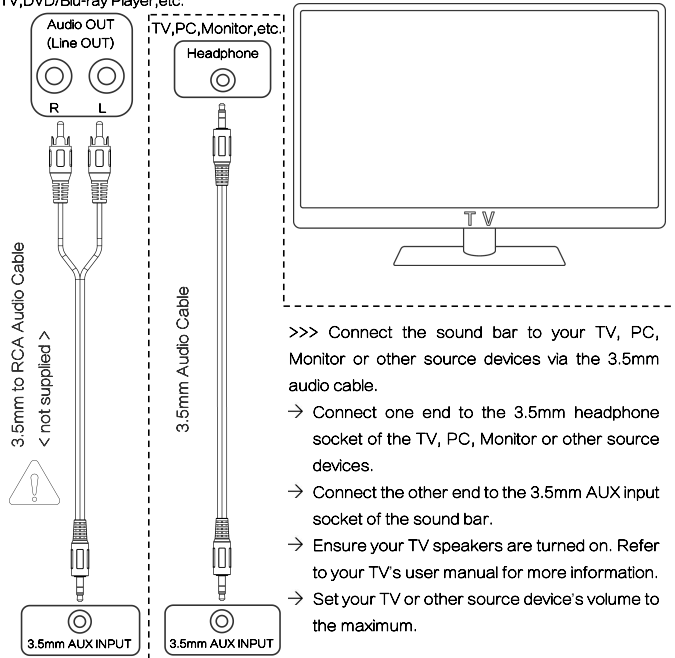

>>> Connect the sound bar to your TV, PC, Monitor or other source devices via the 3.5mm audio cable.

- Connect one end to the 3.5mm headphone socket of the TV, PC, Monitor or other source devices.
- Connect the other end to the 3.5mm AUX input socket of the sound bar.
- Ensure your TV speakers are turned on. Refer to your TV's user manual for more information.
- Set your TV or other source device's volume to the maximum.

Note: For audio cable connection, you can boost / restore the volume by double clicking the boost button on the remote control.

## > Using the System

### >> Using the remote control

#### >>> Inserting/replacing batteries

1. Slide to open the battery compartment cover.
2. Insert 2 X 1.5V AAA batteries (not supplied) into the battery compartment. Match the polarity markings in the battery compartment.
3. Close the battery compartment cover.

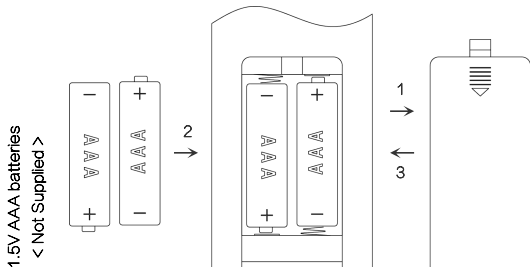

→ If the remote control does not work, open the battery cover and check that the positive terminal of the battery is in good contact with the spring in the groove.



#### Caution!

- The sound bar can only work with the remote control package included, not compatible with universal remote control.
- Always insert the batteries according to the correct polarity markings.
- Use only high quality batteries, low quality batteries might leak and cause damage.
- Remove the batteries from the remote control if you are not using it for an extended period. The remote control could become damaged in case of battery leakage.

#### >>> Tips for usage

- If the remote control does not work properly, replace the batteries.
- Make sure there are no obstacles between the remote control and Sound bar.
- The remote control may be less effective if:
  1. There are obstacles between the remote control and the infrared receiver.
  2. Other remote controls are operated at the same time.
  3. The battery power is low.

## > Using the System

### >> Get power and started

Make sure all the source connections are made properly before you connect the power adapter. Plug the power adapter to the DC IN socket, then to a suitable electrical outlet.

The power indicator lights up red. Indicating the sound bar is in standby mode.

- Turning off your TV speakers: To avoid hearing distorted sound, turn off your TV speakers (except for the headphone socket connection, Refer to "Audio cable connection" for more information).
- Power on your sound bar: Press the Power button on the sound bar or remote control. The power indicator lights up.
- Check if sound is coming from the sound bar.

### >> Selecting a sound mode ( Movie / Music / News )

- To get a better sound effect, press the movie, music or news button on the remote control to select a suitable sound mode.
- There is no sound mode button on the soundbar, Please keep the remote control properly.
- The recommended sound mode selections as below:

Program source	Sound mode	Program source	Sound mode
Strong bass film	Music or news	Strong bass music	Music or news
General film	Movie or music	Pop music	Movie or Music
Documentary	Music or news	Light music	Music or news
Variety show	Music or news	News / Dialog	Music or news

#### Notes:

- For the better sound quality, please set the volume of the sound bar to 80 percent of maximum ( Note: the maximum volume drop 2 levels is 80 percent ) and set the volume of your source device to a suitable level.
- There is no sound mode indicator on the soundbar. 
- The sound mode selection and the volume settings are saved in the memory even after the sound bar is powered off, and the volume setting from 80 percent to maximum will be saved to 80 percent.
- Set the volume of your source device to a low level before switching on the sound bar. Then increase the volume of your source device to a comfortable level.
- Disconnect the power adapter from the electrical outlet to power off your sound bar completely.

## > Using the System

### >> Basic functions

#### >>> Selecting a source

- You can have several source devices connected permanently to the sound bar.
- Available sources are: OPT / ARC / BT / AUX

Source	Function
OPT	Optical , connection with an optical fiber cable.
ARC	HDMI ARC, Connection to the TV with a HDMI Cable (not supplied).
BT	Bluetooth, Connection to a Bluetooth Device.
AUX	Auxiliary, Connection with a 3.5mm to RCA audio cable (not supplied).
	Auxiliary, Connection with a 3.5mm to 3.5mm audio cable.

- Press the M ( Mode ) button repeatedly on the sound bar or press the OPT, ARC, BT, AUX button on the remote control to toggle between the sources, The OPT, ARC, BT, AUX source indicator will light up accordingly.
- You can boost / restore the volume by double clicking the boost button on the remote control when you use AUX source (audio cable connection).

#### >>> Play back functions

- Normally playback functions can be managed through the controls of the connected source device.
- Alternatively, use the remote control and the buttons of the sound bar.

Key	Press Key	Function
M	1 X	Source selection
	Long press 2 second	Disconnecting the Bluetooth device
<< / >>	1 X ( DS6401 )	Skip to the beginning of the previous / next title
Sub- / Sub+	1 X ( DS6541 )	Subwoofer volume down / Subwoofer volume up
- / +	1 X	Volume down / Volume up
>   / mute	1 X	Pause / Mute sound (Flash the indicator light).
	2 X	Play / Restore sound.

#### Notes:

- The volume boost / restore and mode (source) selections are saved in the memory even after the sound bar is powered off.
- The audio output of the sound bar is affected by the settings of the connected source. If necessary, adjust the settings of the source to improve the audio output.

## > Using the System

### >> Bluetooth function

External Bluetooth devices can be connected to the TV sound bar system via Bluetooth connection.

1. Press the BT button on the remote control to enter the Bluetooth mode. The Bluetooth indicator lights up blue.
2. Activate the Bluetooth function of the external device and search for Bluetooth devices.
3. Select the sound bar (Sine Audio) from the Bluetooth device list.
4. Follow the instructions shown on your device's screen.
5. When the Bluetooth connection is established, files from your connected Bluetooth device will be played through the sound bar.

### >> Disconnecting the Bluetooth device:

- Press M (Mode) button on the sound bar to enter AUX or OPT (optical) mode.
- Press the OPT or AUX button on the remote control to enter AUX or OPT (optical) mode.
- Disconnect using your Bluetooth device. The sound bar starts searching for another Bluetooth device.
- Long press the BT button on the remote control or M (Mode) button on the sound bar about 2 seconds to disconnect the current Bluetooth device. Long press about 2 seconds again to reconnect the current Bluetooth device.



→ Recommended to use optical cable to connect with your TV, Bluetooth connection may cause audio delay.

#### Notes:

- If you cannot pair your Bluetooth device, you may need to remove the sound bar from the pairing list, and try pairing again (see " Troubleshooting " for more information).
- Bluetooth works best within a range of up to 33 feet (10 meters).
- The music streaming may be interrupted by obstacles between the Bluetooth device and sound bar, such as walls, metallic casing that covers the device, or other devices nearby that operate in the same frequency.
- If the connected device goes out of Bluetooth range, the system will reconnect automatically when the device comes back within range.
- The current Bluetooth device connection is saved in the memory even after the sound bar is powered off.

## &gt; Troubleshooting

Problem	Solution
No power	<ul style="list-style-type: none"> <li>→ Check the power adapter is properly connected to an electrical outlet.</li> <li>→ Check the DC plug is properly connected to the DC IN socket.</li> <li>→ Unplug the power adapter for at least one minute and reconnect.</li> </ul>
No Sound	<ul style="list-style-type: none"> <li>→ Press the Power button on the sound bar or remote control to turn on the sound bar. The mode(source) indicator lights up.</li> <li>→ Press MUTE button on the remote control to restore sound.</li> <li>→ Ensure that the source device has correct volume settings and is playing a track.</li> <li>→ Ensure the correct source device is selected.</li> <li>→ Plug the audio cable into a connector on your TV labeled Line OUT or Audio OUT, not Line IN or Audio IN.</li> </ul> <p>Digital audio (SPDIF) connection:</p> <ul style="list-style-type: none"> <li>→ Plug the optical cable into a socket on your TV labeled Optical OUT or Digital OUT, not Optical IN or Digital IN.</li> <li>→ Plug the HDMI cable (not supplied) into a port on your TV labeled HDMI ARC, not HDMI.</li> <li>→ Activate PCM (Pulse Code Modulation) in the audio settings menu of your source device(see your source device's user manual).</li> </ul> <p>Connect to the headphone socket of TV:</p> <ul style="list-style-type: none"> <li>→ Increase your TV's volume to maximum.</li> <li>→ Turn on your TV speakers, Refer to your TV's user manual for more information.</li> </ul>
Poor audio quality	<ul style="list-style-type: none"> <li>→ Press the movie, music or news button on the remote control to select a suitable sound mode.</li> <li>→ Set the volume of the sound bar to 80 percent of maximum ( Note: the maximum volume drop 2 levels is 80 percent ) .</li> <li>→ Secure cable connections on the sound bar and TV (or other connected sources).</li> <li>→ Try with different source devices. If the problem still exists, check the cable connections.</li> <li>→ Ensure that the cables connected to the source devices are correctly plugged in and the plugs are fully inserted.</li> </ul>

## &gt; Troubleshooting

Problem	Solution
Poor audio quality	<p>→ Reduce the volume of your source device.</p> <p>Audio cable connection:</p> <p>→ Double clicking the boost button on the remote control to restore the volume.</p> <p>Bluetooth connection:</p> <p>→ Bring the Bluetooth device closer to the sound bar and make sure that no obstacles are disturbing the connection.</p>
Remote control does not work	<p>→ Ensure that the batteries are correctly inserted; if necessary, replace the batteries.</p> <p>→ Bring the remote control closer to the sound bar and make sure there are no obstacles in between. Ensure the remote control is within 16.5 feet (5 meters) of the system.</p> <p>→ Aim the remote control directly at the infrared receiver of the system.</p>
System doesn't react	<p>→ It is malfunction probably due to electrostatic discharge.</p> <p>→ Unplug the power adapter for at least one minute and reconnect.</p>
Bluetooth device cannot be connect to the sound bar	<p>→ Bring the Bluetooth device closer to the sound bar.</p> <p>→ Switch off your device and/or sound bar, then back on, repeat the pairing process.</p> <p>→ Make sure the sound bar is not connected another Bluetooth device.</p> <p>→ Make sure that you have selected the sound bar from the Bluetooth device list on your device.</p> <p>→ Ensure you are using the correct device.</p> <p>If the device is still not connected, try the following:</p> <p>→ Remove the sound bar (Sine Audio) from the list of "paired devices" on your phone/tablet.</p> <p>→ Turn the sound bar off and then on again.</p> <p>→ Pair it again with your phone/tablet. It should now successfully establish the pairing.</p> <p>Note: If none of the above solutions works, the Bluetooth device may be malfunctioning. Try another Bluetooth device. If not even the new device can be connected, the sound bar may be malfunctioning. In this case, please consult your dealer for repair.</p>